

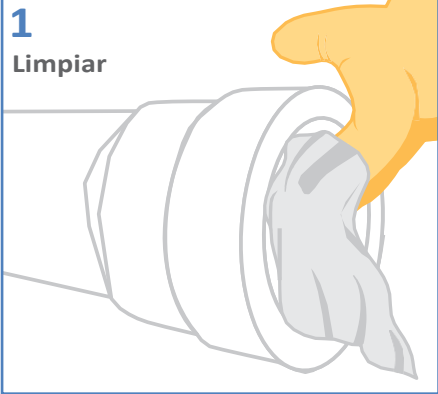

**Montaje de la Junta Blutop® y Blutop® Vi**  
Blutop® o Blutop® VI – Recomendaciones de instalación

**1**  
Limpiar



**2**  
Lubricar pista de junta



**3**

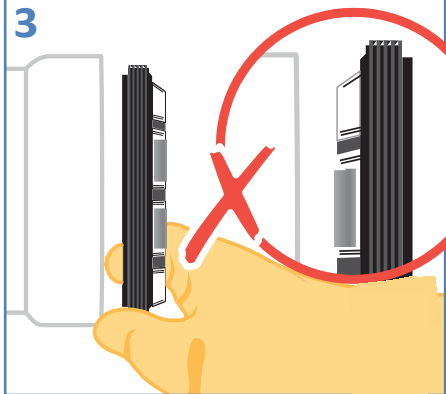

**4**  
Presentar junta



**5**  
Colocar junta

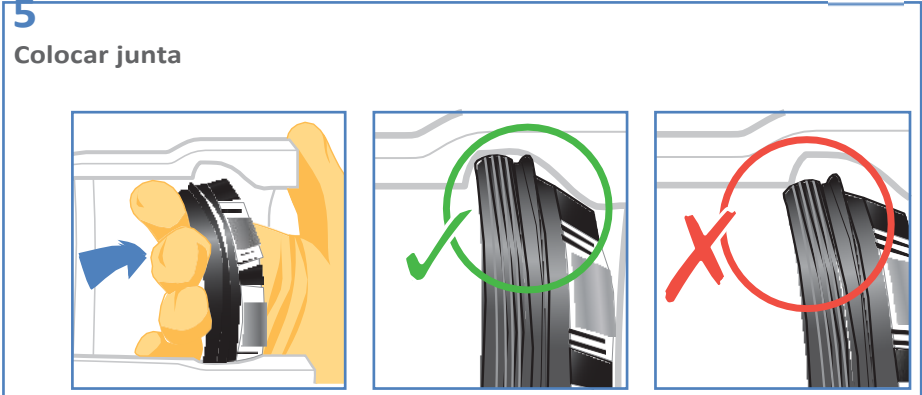

**6**  
Ajustar junta

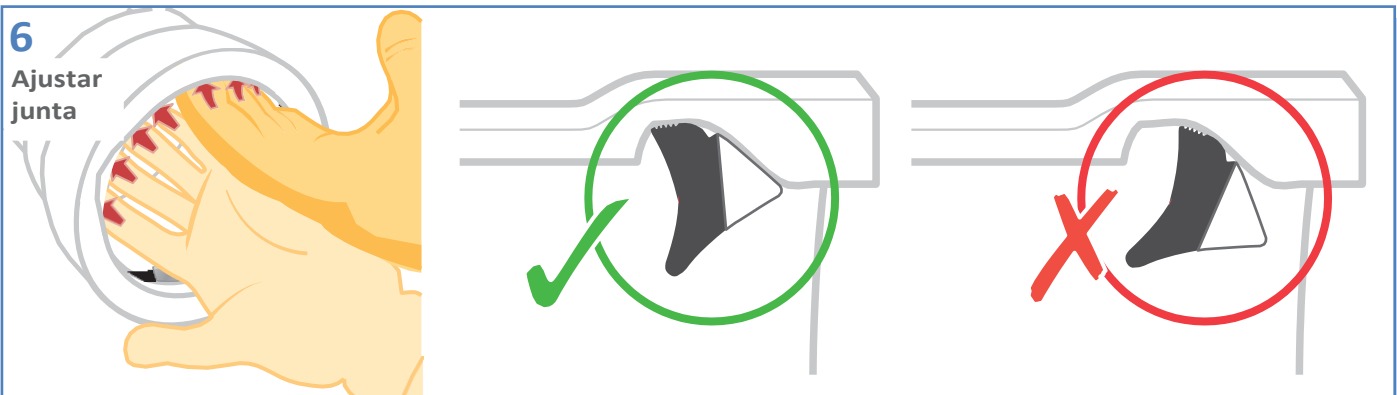

**7**  
Lubricar la junta

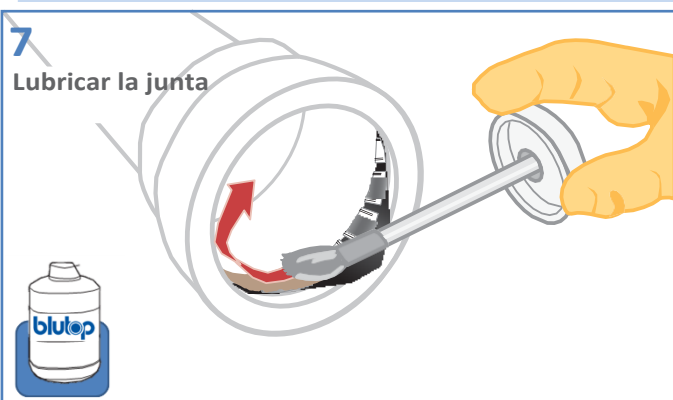

**8**  
Lubricar el liso

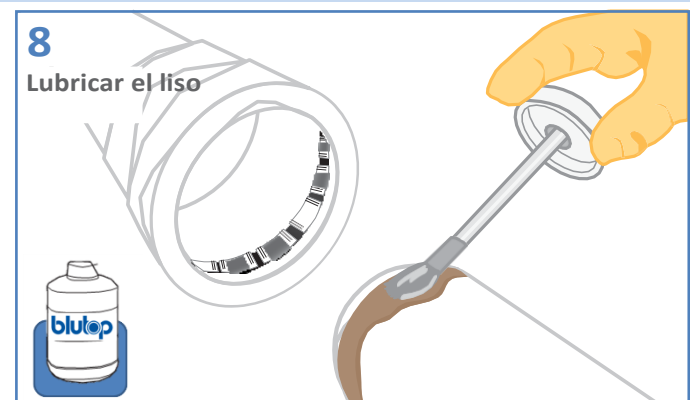

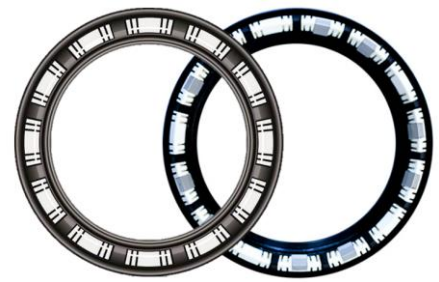

**Montaje de la Junta Blutop® y Blutop® Vi**  
Blutop® o Blutop® VI – Recomendaciones de instalación

**9**

Verificar las dimensiones del chaflán

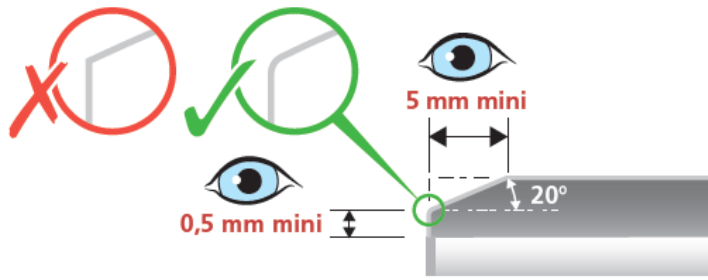

**11**

Verificar profundidad de enchufado

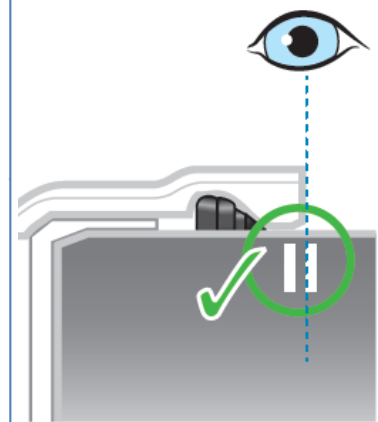

**10**

Enchufado alineado

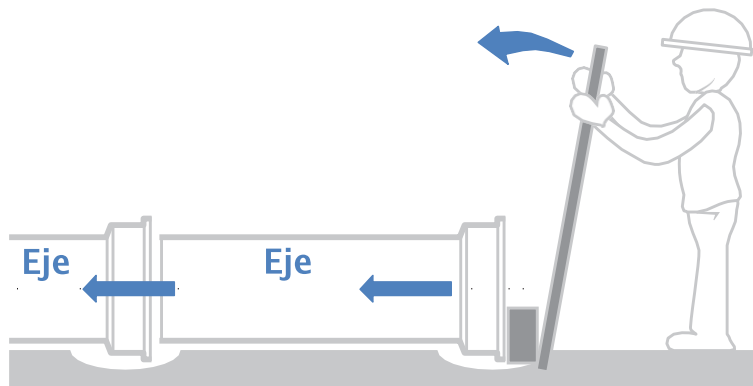

**12**

Verificar la correcta posición de la junta

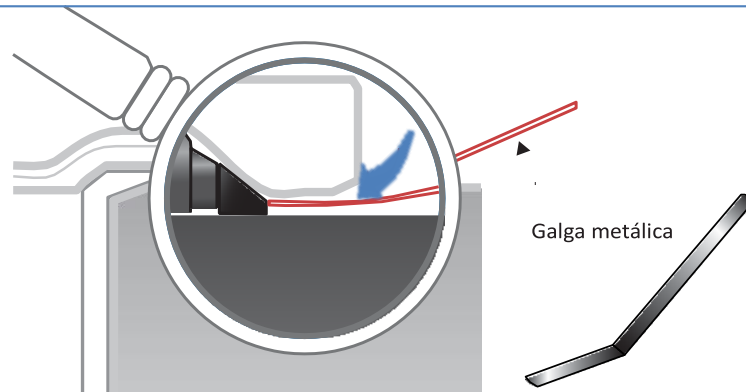

**13**

Dar la desviación angular a posteriori

